



Domino Ax-Series Spares Catalogue

Ax150i

Ax350i

Ax550i

Contents

Introduction	2
Consumable Kits, Tools & Consumables	3
Consumable Kits.....	3
Tools.....	5
Consumables	9
1st, 2nd & 3rd Level Spares	11
1 st Level Spares.....	11
2 nd Level Spares.....	12
3 rd Level Spares	15
i-Pulse Print Head Chassis	22
i-Pulse Print Head Assembly	31
i-Pulse RS Print Head Assembly	36
Duo Print Head Assembly	39
i-Techx System	43
Electronics Cabinet	55
AirDryer Spares	65
Documentation	67
Notes	69

Introduction

This document provides useful information about the current Ax-Series ancillaries and spares including photography, part numbers and descriptions.

Note: This is a working document and will be continuously updated. The newest version of this document will always be available from MyDomino.

Consumable Kits, Tools & Consumables

Consumable Kits





Image	Description	Quantity per kit
	<p>EPT025724 Starter Kit - Type 5</p> <p>Kit Components: Wash Bottle 250ml Safety Glasses Low Lint Tissue Hycare (Sheet) Gloves, Disp Nitrile (Blue), Latex & Powder, Large Wash Station Jug Hand Cleaner, Small 30ml Tube Print Head Cleaning Brush</p> <p>Note: Low Lint Tissue and Wash Station Jug not available separately.</p>	<p>1 1 10 20 1 1 1</p>
	<p>EPT025349 Performance Kit - A-Series</p> <p>Kit Components: Size L Blue Nitirle Powder Free Gloves Lint Free Wipes Safety Glasses Cleaning Bottle Hand Cleaner - Small 30ml 400ml Plastic Beaker T6 Torx Driver 6mm S/A Allen key 1.5mm Ball Allen Key 2mm Ball Allen Key Eye Glass</p> <p>Note: Lint Free Wipes not available separately.</p>	<p>1 Pack 10 1 1 1 1 1 1 1 1</p>

Image	Description	Quantity per kit
	<p>ITM02 Ax-Series ITM Type 2 (Designed for Normal Ink System)</p> <p>ITM03 Ax-Series ITM Type 3 (Designed for Heavy Duty Ink System)</p> <p>ITM06 Ax-Series ITM Type 6 (Designed for Dye-Based Ink System)</p>	<p> </p> <p> </p> <p> </p>
	<p>26055 Cleaning Kit</p> <p>Kit Components: Wash Bottle 250ml Hand Cleaner 250g Gloves, Natural Rubber Latex Disp, Powder Free, Large Paper 8" Dia x 10" M Tork</p>	<p> </p> <p> </p> <p> </p> <p> </p>

Tools

Image	Description	Quantity per kit
	EPT034408 Short Jaw 8mm Spanner	1
	EPT032546 Torx Driver Toolkit Kit Components: Screwdriver T6 x 75mm Screwdriver T10 x 75mm Screwdriver T15 x 100mm Screwdriver T20 x 100mm Screwdriver T25 x 125mm Flexible Nut Spinner 7mm x 150mm Note: Kit components not available separately.	1 1 1 1 1 1
	EPT032301 T6 Torx Driver	1
	30455 AirDryer Test Kit Kit Components: Test Instructions Flow Meter and Chart Syringe 20ml Humidity Meter Tubing Silicone 7mm OD 3mmID Note: Only Flow Meter and Chart available separately.	1 1 1 1 0.6M





Image	Description	Quantity per kit
	<p>30457 Flow Meter & Chart</p>	<p>1</p>
	<p>26083 Beaker (Earthed)</p> <p>Kit Components: Metal Beaker (550ml) Cable Assembly Nut M4 St St Washer M4 Shake proof St St Screw PAN Pozi St St M4x6</p> <p>Note: Kit components not available separately.</p>	<p>1 1 1 2 1</p>
	<p>10700 Wrist Strap Coiled (1.5M Anti-Static)</p>	<p>1</p>
	<p>14484 Ball Driver (1.5mm)</p>	<p>1</p>





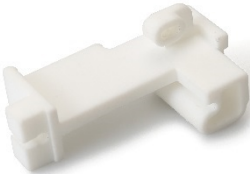
Image	Description	Quantity per kit
 A black, cylindrical eye glass with a flat top and a slightly flared base.	I4547 Eye Glass	1
 A pair of clear, wrap-around safety glasses with a strap across the bridge.	I4584 Safety Glasses	1
 A red, handheld tube cutter with a curved blade and a handle.	I4549 Tube Cutters	1
 A white, plastic wash bottle with a white cap and a white nozzle.	I4563 Wash Bottle (250ml)	1

Image	Description	Quantity per kit
	EPT054062 Ax Deflector Plate Setting Gauge	1

Consumables

Image	Description	Quantity per kit
	<p>26046 Hand Cleaner (250g)</p>	<p>1</p>
	<p>99116 Paper 8" Dia x 10" M Tork</p>	<p>1</p>
	<p>Nitrile Gloves</p> <p>Small - 99289 Large (Large Box) - 99291 Large (Small Box) - EPT038910 Extra Large - 99292</p> <p>Note: Large box contains 100 gloves and small box contains 20 gloves.</p>	<p>1 1 1 1</p>

Image	Description	Quantity per kit
	<p>Latex Gloves, Powder Free</p> <p>Small - 99199 Medium - 99192 Large (Large Box) - 99119 Large (Small Box) - EPT052312</p> <p>Note: Large box contains 100 gloves and small box contains 20 gloves.</p>	<p> </p>
	<p>Inks and Make-Up</p> <p>Note: May vary depending on printer model, options and set up, please contact Domino.</p>	<p>N/A</p>

1st, 2nd & 3rd Level Spares


1st Level Spares

Image	Description	Quantity per kit
	<p>EPT015415SP Filter Assembly Type 5 Spare</p>	<p>1</p>
	<p>ITM02 Ax-Series ITM Type 2 (Designed for Normal Ink System)</p> <p>ITM03 Ax-Series ITM Type 3 (Designed for Heavy Duty Ink System)</p> <p>ITM06 Ax-Series ITM Type 6 (Designed for Dye-Based Ink System)</p>	<p>1</p> <p>1</p> <p>1</p>
	<p>01210 Fuse 20x5 (T)1A (240V)</p>	<p>1</p>

2nd Level Spares

Image	Description	Quantity per kit
	<p>EPT013403SP Module Latch (x2) Kit Type 5 Spare</p>	<p>2</p>
	<p>EPT021504SP Low Drip Valve Type 5 Spare</p>	<p>1</p>
	<p>EPT021551SP Ink System O-Ring Kit Type 5 Spare</p> <p>Kit Components:</p> <ul style="list-style-type: none"> O-Ring 8.73 x 1.78 EPDM 20 O-Ring 9.0 x 2.0 EPDM 20 Reservoir O-Ring 10 O-Ring 11.0 x 2.0 EPDM 10 O-Ring 12.42 x 1.78 EPDM 20 ORING 2.9X1.78 EPDM 10 ORING 4_48X1_78 EPDM 40 ORING 5.28X1.78 EPDM 10 ORING 6.5X1.5 EPDM 10 <p>Note: Ink System O-Ring Kit components not available separately.</p>	<p>20</p> <p>20</p> <p>10</p> <p>10</p> <p>20</p> <p>10</p> <p>40</p> <p>10</p> <p>10</p>

Image	Description	Quantity per kit
	<p>EPT021552SP Ink System Fasteners Kit Type 5 Spare</p> <p>Kit Components: Screw 3 x 24.5 WNI56-2 T10 A2 Remform Screw K40 x 14 WNI45I Screw 3 x 10 WNI56-2 T10 A2 Remform Screw 3 x 8 WNI56-1 T10 A2 Remform Screw 3 x 18 WNI56-2 T10 A2 Remform</p> <p>Note: Ink System Fastener Kit components not available separately.</p>	<p>100</p> <p>60</p> <p>200</p> <p>100</p> <p>50</p>
	<p>EPT022060SP Cabinet Fasteners Kit Type 5 Spare</p> <p>Kit Components: Screw M3 x 10 BUT FLG Torx T10 SS K30 PLAS-TECH Screw M4 x 10 HEX HD SS Captive Washer Washer M4 Shake Proof St St Screw M5 x 8 CSK HD Torx T25 SS Screw M5 x 30 CAP HD Torx T25 SS Screw M4 x 20 HEX HD SS Captive Washer Screw M3 x 8 CSK HD Torx T10 SS Screw M3 x 8 BUT HD Torx T10 SS IP65 Nylon Washer Screw M3 x 8 BUT HD Torx T10 SS Captive Washer Screw M4 x 45 BUT HD Torx T20 SS Captive Washer Screw M3 x 5 BUT HD Torx T10 SS Captive Washer</p> <p>Note: Cabinet Fastener Kit components not available separately.</p>	<p>60</p> <p>40</p> <p>20</p> <p>30</p> <p>30</p> <p>40</p> <p>20</p> <p>40</p> <p>100</p> <p>20</p> <p>40</p>

Image	Description	Quantity per kit
	<p>EPT021664SP Print Head Fasteners Kit Type 5 Spare</p> <p>Kit Components:</p> <p>Screw M2.2 x 8 PAN HD Torx T6 SS K22 PLAS-TECH 80</p> <p>Screw M2 x 4 CAP HD Torx T6 SS 20</p> <p>Screw M2 x 6 CAP HD Torx T6 SS 20</p> <p>Screw M2 x 6 CAP HD Torx T6 SS Captive Washer 100</p> <p>Screw M3 x 5 BUT HD Torx T10 SS 10</p> <p>Screw M4 x 6 BUT HD Torx T20 SS 10</p> <p>Screw M3 x 6 CSK HD Torx T10 SS 20</p> <p>Screw CSK Pozi, M2 x 5 St St 10</p> <p>Nut Lock M3 10</p> <p>Screw M2 x 8 CAP HD Torx T6 SS 10</p> <p>Screw M3 x 10 BUT FLG Torx T10 SS K30 PLAS-TECH 20</p> <p>Screw M3 x 16 BUT FLG Torx T10 SS K30 PLAS-TECH 10</p> <p>Screw M2 x 12 CAP HD Torx T6 SS 10</p> <p>Note: Print Head Fastener kit components not available separately.</p>	

3rd Level Spares




Image	Description	Quantity per kit
	<p>Nozzle Kit Type 5 Spare</p> <p>EPT036539SP - 40 Micron EPT036546SP - 50 Micron 2-0160125SP - 60 Micron 2-0160124SP - 75 Micron</p> <p>Kit Components: Positive Tag Piezo Ceramic Disc Insulating Sleeve O-Ring EPDM 3.3 ID x 0.95 CS 60/ 75 Micron Nozzle Assembly Wire 7/0.2 Pink Crimp Minitex 22-24 AWG</p> <p>Note: Kit components not available separately.</p>	<p>1 1 1 1 1 2 1 1 1 1 1</p>
	<p>2-0110165SP Piezo Ceramic Disc (x2) Kit Type 5 Spare</p>	<p>1</p>
	<p>2-0110158SP Nozzle O-Ring Kit (x10) Type 5 Spare</p> <p>Kit Components: O-Ring EPDM 3.3 ID x 0.95 CS</p>	<p>1 10</p>
	<p>Heater, Thermistor and Solenoid Assembly Type 5 Spare</p> <p>50, 60, 75 µm - EPT006277SP 40 µm - EPT034640SP</p>	<p>1 1</p>

Image	Description	Quantity per kit
	<p>EPT006886SP High Voltage PSU Type 5 Spare</p>	<p>1</p>
	<p>EPT033207SP LVPS 2 Ultrawide & 6A Power Connector Kit Spare</p>	<p>1</p>
	<p>EPT026355SP Power Connector Type 6 Spare</p>	<p>1</p>
	<p>EPT007517SP Gutter Pump Type 5 Spare</p>	<p>1</p>
	<p>EPT009810SP Make-Up Module Type 5 Spare</p>	<p>1</p>

Image	Description	Quantity per kit
	<p>EPT023718SP Solenoid Assembly Ink Block Type 5 Spare</p>	<p>1</p>
	<p>EPT013308SP Product Detect / Shaft Encoder PCB Kit Type 5 Spare</p> <p>Kit Components: Product Detect / Shaft Encoder PCBA - Dual Cap, Protection, Female Socket Cable, Product Detect / Shaft Encoder</p> <p>Note: Kit components not available separately.</p>	<p>1 2 1</p>
	<p>EPT013507SP Viscometer Assembly Kit Type 5 Spare</p> <p>Kit Components: Viscometer Assembly Basic General Build (Bayonet) LLDPE Tubing 6mm Natural</p> <p>Note: Tubing available separately.</p>	<p>1 0.4M</p>
	<p>Strobe & Charge Electrode Assembly Type 5 Spare</p> <p>40 & 50 µm - EPT032311SP 60, 75 µm & H90 - EPT015169SP V90 - EPT033576SP</p>	<p>1 1 1</p>

Image	Description	Quantity per kit
	<p>EPT016969SP Pressure Sensor Type 5 Spare</p>	<p>1</p>
	<p>EPT016967SP Vacuum Sensor Type 5 Spare</p>	<p>1</p>
	<p>EPT017291SP Fan Assembly Type 5 Spare</p>	<p>1</p>
	<p>Deflector Plate Assembly Type 5 Spare</p> <p>40 µm - EPT026585SP 50 µm - EPT026590SP 60, 75 µm & H90 - EPT017396SP V90 - EPT033546SP</p>	<p>1 1 1 1</p>





Image	Description	Quantity per kit
	EPT017909SP Main Control PCB Type 5 Spare	1
	EPT018862SP Feed Filter Assembly Type 5 Spare	1
	EPT018872SP Damper Assembly Type 5 Spare	1
	EPT019977SP Programmed 8GB Flash Card Type 5 Spare	1







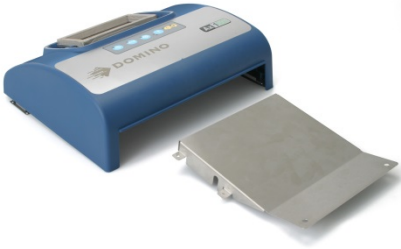
Image	Description	Quantity per kit
	<p>EPT019979SP 32KB Smart Card Type 5 Spare</p>	<p>1</p>
	<p>EPT021516SP Jet Pump Kit Type 5 Spare</p> <p>Kit Components: Jet Pump Nozzle Vertical Shield O-Ring 12.45 x 1.78 EPDM O-Ring 6.5 x 1.5 EPDM</p> <p>Note: Kit components not available separately.</p>	<p>1</p>
	<p>EPT021639SP Print Head Cover Kit Type 5 Spare</p> <p>Kit Components: Holster Retaining Clips Wire Box Lid Seal Wirebox Cover Wirebox Dovetail Wirebox</p> <p>Note: Kit components not available separately.</p>	<p>2 1 1 1 1 1</p>
	<p>EPT023712SP Gear Pump Assembly Type 5 Spare</p> <p>Kit Components: Gear Pump LLDPE Tubing 6mm Natural LLDPE Tubing 8mm Natural</p> <p>Note: Tubing available separately.</p>	<p>1 0.435M 0.415M</p>

Image	Description	Quantity per kit
	<p>EPT027778SP Cable, Stroboscope, 3M</p> <p>Note: For use with Stroboscope and Cable - EPT027809, in Ax-Series Accessories Catalogue.</p>	<p>1</p>
	<p>EPT028743SP Front Door UI Parts Kit (Ax150i) Spare</p> <p>Kit Components: Screw M3 x 10 BUT FLG Torx T10 SS K30 PLAS-TECH PCBA 7" UI HEX Stand Off Cable, UI Cable, Keypad 7" UI Front Assembly</p> <p>Note: Kit components not available separately.</p>	<p>12 1 2 1 1 1</p>
	<p>EPT029088SP Front Door Assembly (No UI) Parts Kit (Ax150i) Spare</p>	<p>1</p>

i-Pulse Print Head Chassis




Image	Description	Quantity per kit
	<p>Print Head & Conduit Assembly Type 5 Spare</p> <p>3M 40 µm - EPT032898SP 4M 40 µm - EPT032899SP 3M 50 µm - EPT032930SP 4M 50 µm - EPT032931SP 3M 60 µm - EPT027442SP 6M 60 µm - EPT027785SP 3M 75 µm - EPT027786SP 6M 75 µm - EPT027787SP</p>	<p>I I I I I I I I</p>
	<p>Print Head & Conduit Assembly H90 Type 5 Spare</p> <p>3M 60 µm - EPT027984SP 6M 60 µm - EPT027986SP 3M 75 µm - EPT027985SP 6M 75 µm - EPT027987SP</p>	<p>I I I I</p>
	<p>Print Head & Conduit Assembly V90 Type 5 Spare</p> <p>3M 60 µm - EPT034167SP 6M 60 µm - EPT034165SP 3M 75 µm - EPT034168SP 6M 75 µm - EPT034166SP</p>	<p>I I I I</p>


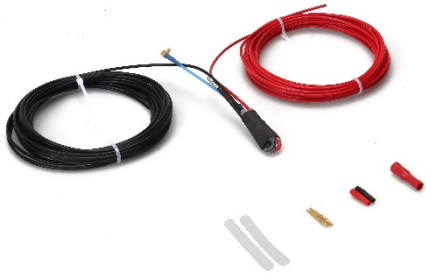
Image	Description	Quantity per kit
	<p>Conduit Assembly</p> <p>3M 40 & 50 µm - EPT018086SP</p> <p>3M 60 & 75 µm - EPT015181SP</p> <p>4M 40 & 50 µm - EPT018097SP</p> <p>4M 60 & 75 µm - EPT018097SP</p> <p>6M 60 & 75 µm - EPT017598SP</p> <p>Note: Conduit type dependant on ink type and print head combination.</p>	<p>I</p> <p>I</p> <p>I</p> <p>I</p> <p>I</p>
	<p>EPT058523 Ax EHT Replacement Kit Type 5 Spare</p> <p>Kit Components:</p> <p>Wire 19/0.2 9KV PTFE Black</p> <p>Wire 19/0.2 9KV PTFE Red</p> <p>Sleeving Heat Shrink 3.2 Clear</p> <p>Sleeving Heat Shrink 4.80 Clear</p> <p>Insulated Female Bullet Terminal</p> <p>Plug 2mm 10AMP Black</p> <p>Plug 2mm 10AMP Red</p> <p>Sleeving Heat Shrink 3/8 Inch Black</p>	<p>I</p> <p>I</p> <p>0.10m</p> <p>0.10m</p> <p>I</p> <p>I</p> <p>I</p> <p>0.05m</p>

Image	Description	Quantity per kit
	<p>Print Head Chassis Type 5 Spare</p> <p>40 µm - EPT026812SP 50 µm - EPT027065SP 60, 75 µm - EPT015205SP</p> <p>H90 - EPT022499SP</p> <p>V90 - EPT022294SP</p>	<p>1</p> <p>1</p> <p>1</p> <p>1</p> <p>1</p>
	<p>Holster Assembly Type 5 Spare</p> <p>40 µm - EPT032848SP 50 µm - EPT032929SP 60, 75 µm - EPT019488SP</p> <p>H90 - EPT022521SP</p> <p>V90 - EPT022296SP</p>	<p>1</p> <p>1</p> <p>1</p> <p>1</p> <p>1</p>

Image	Description	Quantity per kit
	<p>EPT024562SP Lens Assembly (Pack of 5) Type 5 Spare</p>	<p>1</p>
	<p>26798 Mounting Plate</p>	<p>1</p>
	<p>EPP001943SP Conduit Sheath 6m (i-Tech/Ax) Spare</p>	<p>1</p>
	<p>EPT021639SP Print Head Cover Kit Type 5 Spare</p> <p>Kit Components:</p> <ul style="list-style-type: none"> Holster Retaining Clips Wire Box Lid Seal Wirebox Cover Wirebox Dovetail Wirebox <p>Note: Kit components not available separately.</p>	<p>2</p> <p>1</p> <p>1</p> <p>1</p> <p>1</p> <p>1</p>

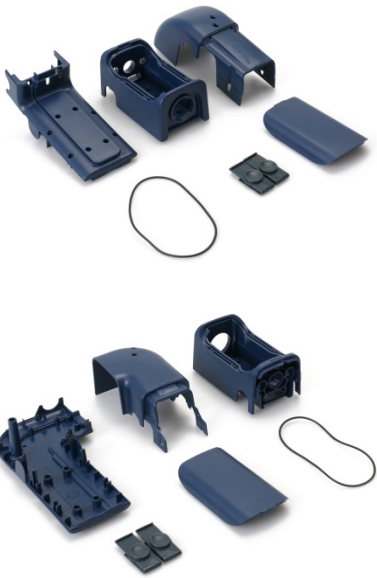
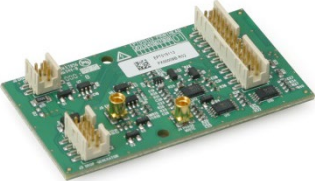
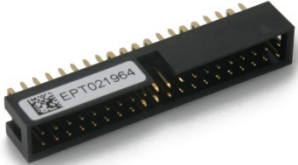
Image	Description	Quantity per kit
	<p>i-Pulse Maintenance Kit Type 5 Spare</p> <p>V90 - EPT045623</p> <p>H90 - EPT045624</p>	<p>I</p> <p>I</p>
	<p>EPT033017SP Print Head PCBA 40/50/60/75 µm Type 5 Spare</p>	<p>I</p>
	<p>Jumper Link Connector Type 5 Spare</p> <p>3M 40 µm - EPT021966SP</p> <p>4M 40 µm - EPT021967SP</p> <p>3M 50 µm - EPT036400SP</p> <p>4M 50 µm - EPT036401SP</p> <p>3M 60 µm - EPT021964SP</p> <p>6M 60 µm - EPT021965SP</p> <p>3M 75 µm - EPT021970SP</p> <p>6M 75 µm - EPT021971SP</p>	<p>I</p> <p>I</p> <p>I</p> <p>I</p> <p>I</p> <p>I</p> <p>I</p> <p>I</p>

Image	Description & Location	Quantity per kit
	<p>98121 Sleeving Heat shrink 3mm BK S/A</p>	<p>Sold by Metre</p>
	<p>98201 Tube PTFE 1/8 Nat to Spec</p>	<p>Sold by Metre</p>
	<p>01042 Skt Brass Turned 1.02mm PIN</p>	<p>1</p>
	<p>01043 Plug PIN 1.02mm PIN Brass Gold</p>	<p>1</p>



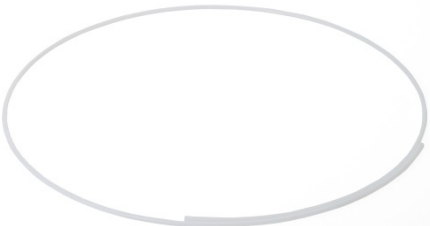

Image	Description	Quantity per kit
	<p>98094 Sleeving Heat Shrink 4.80 Clear</p>	<p>Sold by Metre</p>
	<p>98108 Sleeve Heat Shrink 3.2mm Black</p>	<p>Sold by Metre</p>
	<p>2-0140061SP Tube PTFE 2 ID x 0.5 Wall</p>	<p>Sold by 10 Metre</p>
	<p>EPT034279SP Tube Kit Type 5 Spare</p> <p>Kit Components: LLDPE Tubing 6mm Natural Tube 8mm x 415mm - LLDPE</p> <p>Note: Kit components not available separately.</p>	<p>2M 0.415M</p>





Image	Description	Quantity per kit
	<p>EPT018338SP Tube PTFE 3.2mm O/D 1.48mm I/D - Black Stripe 5.05M Spare</p>	<p>Sold by Metre</p>
	<p>EPT026060SP Tube PTFE 3.175 O/D 2.0mm I/D Internal Stripe Violet 7.05M Spare</p>	<p>Sold by Metre</p>
	<p>EPT033199SP Tube PTFE 3.175 O/D 2.2mm I/D Internal Stripe Orange 7.275M Spare</p>	<p>Sold by Metre</p>

Image	Description	Quantity per kit
	<p>EPT021664SP Print Head Fasteners Kit Type 5 Spare</p> <p>Kit Components:</p>	
	Screw M2.2 x 8 PAN HD Torx T6 SS K22 PLAS-TECH	80
	Screw M2 x 4 CAP HD Torx T6 SS	20
	Screw M2 x 6 CAP HD Torx T6 SS	20
	Screw M2 x 6 CAP HD Torx T6 SS Captive Washer	100
	Screw M3 x 5 BUT HD Torx T10 SS	10
	Screw M4 x 6 BUT HD Torx T20 SS	10
	Screw M3 x 6 CSK HD Torx T10 SS	20
	Screw CSK Pozi, M2 x 5 St St	10
	Nut Lock M3	10
	Screw M2 x 8 CAP HD Torx T6 SS	10
	Screw M3 x 10 BUT FLG Torx T10 SS K30 PLAS-TECH	20
	Screw M3 x 16 BUT FLG Torx T10 SS K30 PLAS-TECH	10
	Screw M2 x 12 CAP HD Torx T6 SS	10
	<p>Note: Print Head Fastener kit components not available separately.</p>	

i-Pulse Print Head Assembly

Image	Description	Quantity per kit
	<p>Drop Generator Assembly</p> <p>40 µm - EPT016224SP 50 µm - EPT016225SP 60 µm - EPT015160SP 75 µm - EPT016226SP V90 60 µm - EPT033577SP V90 75 µm - EPT033578SP</p>	<p>1 1 1 1 1 1</p>
	<p>Drop Generator Adapter Type 5 Spare</p> <p>60 µm - EPT009430SP 75 µm - EPT018385SP</p>	<p>1 1</p>
	<p>Nozzle Kit Type 5 Spare</p> <p>EPT036539SP - 40 Micron EPT036546SP - 50 Micron 2-0160125SP - 60 Micron 2-0160124SP - 75 Micron</p> <p>Kit Components:</p> <p>Positive Tag Piezo Ceramic Disc Insulating Sleeve O-Ring EPDM 3.3 ID x 0.95 CS 60/ 75 Micron Nozzle Assembly Wire 7/0.2 Pink Crimp Minitex 22-24 AWG</p> <p>Note: Kit components not available separately.</p>	<p>1 1 1 1 2 1 1 1</p>
	<p>2-0110165SP Piezo Ceramic Disc (x2) Kit Type 5 Spare</p>	<p>1</p>


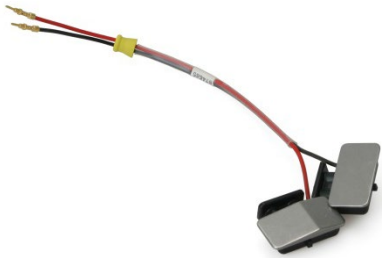



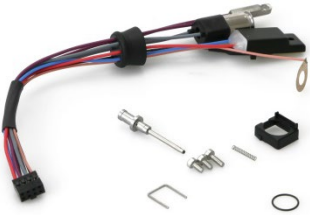

	<p>2-0110158SP Nozzle O-Ring Kit (x10) Type 5 Spare</p> <p>Kit Components: O-Ring EPDM 3.3 ID x 0.95 CS</p>	<p>I</p> <p>10</p>
	<p>Deflector Plate Assembly Type 5 Spare</p> <p>40 µm - EPT026585SP 50 µm - EPT026590SP 60, 75 µm & H90 - EPT017396SP V90 - EPT033546SP</p>	<p>I</p> <p>I</p> <p>I</p> <p>I</p>
	<p>Deflector Plate Assembly Type 5 Spare</p> <p>40 µm - EPT026585SP 50 µm - EPT026590SP 60, 75 µm & H90 - EPT017396SP V90 - EPT033546SP</p>	<p>I</p> <p>I</p> <p>I</p> <p>I</p>
	<p>Strobe & Charge Electrode Assembly Type 5 Spare</p> <p>40 & 50 µm - EPT032311SP 60, 75 µm & H90 - EPT015169SP V90 - EPT033576SP</p>	<p>I</p> <p>I</p> <p>I</p>

Image	Description	Quantity per kit
	<p>EPT042129SP Print Head Adjustment Kit Type 5 Spare</p> <p>Kit Components: Grommet 9.5mm Screw M2x6 Cap HD Torx T6 SS Captive Washer Adjusting Screw Adjusting Shaft Locking Screw Cam Grommet Retaining Screw</p> <p>Note: Kit components not available separately.</p>	<p>2 2 1 1 1 1 2</p>
	<p>EAS003008SP SureStart Earth Clip</p> <p>Note: Mounted on rear of chassis.</p>	<p>1</p>
	<p>EPT015207SP Drop Generator Mount Type 5 Spare</p>	<p>1</p>
	<p>26871 Retainer</p>	<p>1</p>

Image	Description	Quantity per kit
	<p>36726 Pivot Drop Generator Mount</p>	<p>1</p>
	<p>EPT031454SP Gutter Tube Clamp Type 5 Kit</p> <p>Kit Components: Gutter Tube Gutter Tube Clamp Block</p> <p>Note: Kit components not available separately.</p>	<p>1 1</p>
	<p>36706 Tube Connector Gutter</p>	<p>1</p>
	<p>36820 Gutter Tube Adapter</p>	<p>1</p>

Image	Description	Quantity per kit
	<p>EPT063329SP Gutter Tube Kit Type 5 Spare</p> <p>Kit Components: Tube Connector Gutter Gutter Tube Adapter Sensor Tube Std</p>	<p>1 1 1</p>
	<p>Heater, Thermistor and Solenoid Assembly Type 5 Spare</p> <p>50, 60, 75 μm - EPT006277SP 40 μm - EPT034640SP</p>	<p>1 1</p>
	<p>EPT029260SP i-Pulse Flush Adapter Kit Spare</p>	<p>1</p>

i-Pulse RS Print Head Assembly

Image	Description	Quantity per kit
	<p>Print Head & Extruded Conduit Assembly RS Type 5 Spare</p> <p>3M 40 µm - EPT033344SP 3M 50 µm - EPT033346SP 4M 50 µm - EPT033347SP 3M 60 µm - EPT033342SP 6M 60 µm - EPT033343SP 3M 75 µm - EPT033348SP 6M 75 µm - EPT033349SP</p>	<p>I I I I I I I</p>
	<p>Extruded Conduit Assembly Type 5 Spare</p> <p>3M 60/75 µm - EPT031739SP 6M 60/75 µm - EPT032414SP 3M 40/50 µm - EPT032427SP 4M 40/50 µm - EPT032447SP</p>	<p>I I I I</p>
	<p>Holster Assembly RS Type 5 Spare</p> <p>40/75 µm - EPT030206SP 50/60 µm - EPT030092SP</p> <p>Note: No lens included with i-Pulse RS Print Head.</p>	<p>I I</p>
	<p>EPT030027SP Print Head PCBA RS Type 5 Spare</p>	<p>I</p>

Image	Description	Quantity per kit
	<p>EPT030147SP Drop Generator Cover Kit RS Type 5 Spare</p>	<p>1</p>
	<p>Print Head Chassis With H.V. Plates, C.E. & Gutter Assembly RS Type 5 Spare</p> <p>40 µm - EPT030216SP 50/60 µm - EPT030099SP 75 µm - EPT030287SP</p>	<p>1 1 1</p>
	<p>EPT036597SP Print Head O-Ring Kit RS Type 5 Spare</p> <p>Kit Components: O-Ring EPDM 34.65 ID 1.78 CS O-Ring 2.7 x 1.5 O-Ring 4.0 x 1.5 O-Ring 1.5 x 0.5</p> <p>Note: Print Head O-Ring Kit RS components not available separately.</p>	<p>3 9 3 3</p>
	<p>EPT037089SP Fasteners Kit RS Type 5 Spare</p>	<p>1</p>

Image	Description	Quantity per kit
	<p>EPT037091SP Print Head Adjustment Kit RS Type 5 Spare</p>	<p>1</p>
	<p>EPT037095SP Gutter Kit RS Type 5 Spare</p>	<p>1</p>
	<p>EPT026884SP RS Flush Adapter Kit Spare</p>	<p>1</p>
	<p>EPT061435SP RS Print Head Jet Adjustment Shim Kit Spare</p> <p>Kit Components:</p> <ul style="list-style-type: none"> Shim 0.6 C Shim - 0.6 Shim 0.4 C Shim - 0.4 Shim 0.2 C Shim - 0.2 	<ul style="list-style-type: none"> 2 2 3 3 5 5

Duo Print Head Assembly



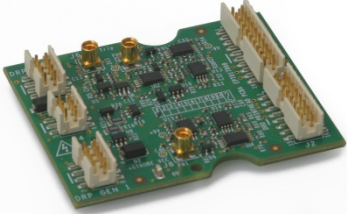

Image	Description	Quantity per kit
	<p>Print Head & Conduit Assembly Duo Type 5 Spare</p> <p>3M 60 μm - EPT033201SP 6M 60 μm - EPT033203SP 3M 75 μm - EPT033202SP 6M 75 μm - EPT033204SP</p>	<p>I I I I</p>
	<p>Conduit Assembly Duo Type 5 Spare</p> <p>3M - EPT019321SP 6M - EPT033200SP</p>	<p>I I</p>
	<p>EPT017898SP Print Head PCBA Duo Type 5 Spare</p>	<p>I</p>
	<p>EPT027338SP Print Head Chassis Duo Type 5 Spare</p>	<p>I</p>

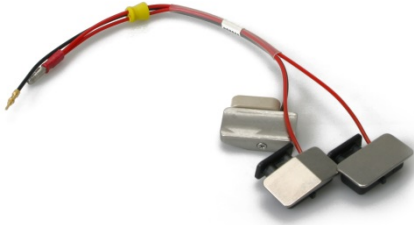




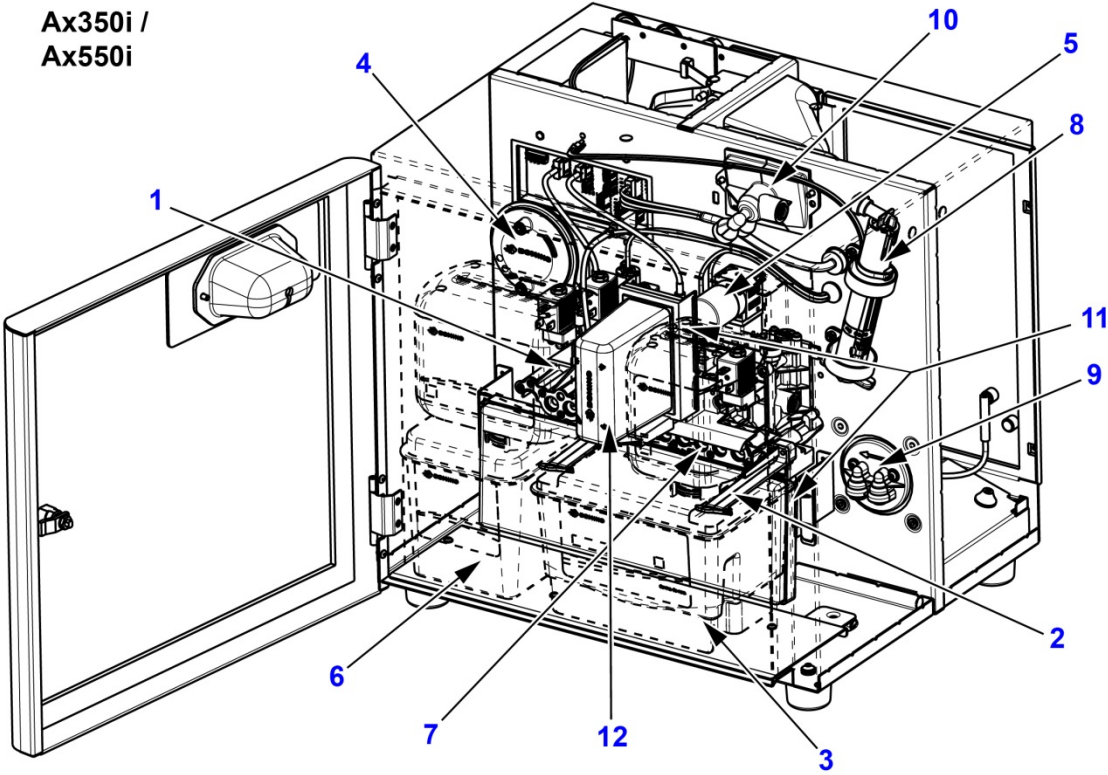
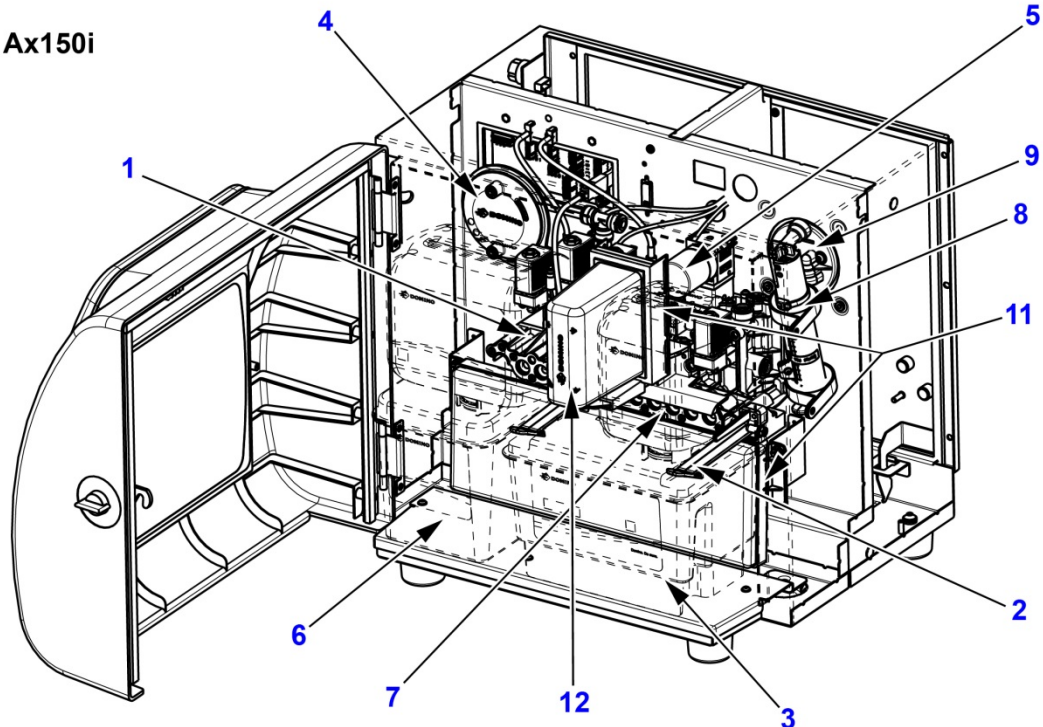



Image	Description	Quantity per kit
	<p>EPT027590SP Deflector Plate Assembly Duo Type 5 Spare</p>	<p>1</p>
	<p>Drop Generator Assembly Duo Type 5 Spare</p> <p>LH 60 µm - EPT014191SP LH 75 µm - EPT014699SP RH 60 µm - EPT014195SP RH 75 µm - EPT014734SP</p>	<p>1 1 1 1</p>
	<p>Strobe & Charge Electrode Assembly Duo Type 5 Spare</p> <p>LH - EPT019616SP RH - EPT017918SP</p>	<p>1 1</p>
	<p>EPT036557SP Duo Print Head Cover Kit Type 5 Spare</p>	<p>1</p>

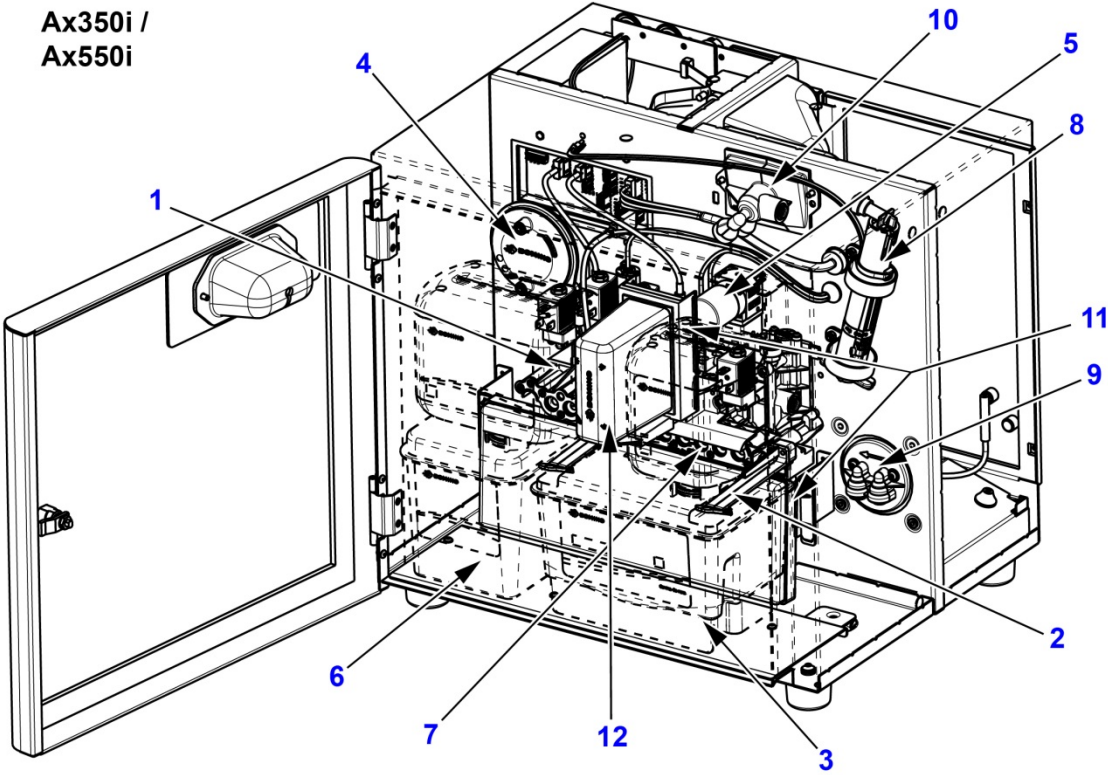
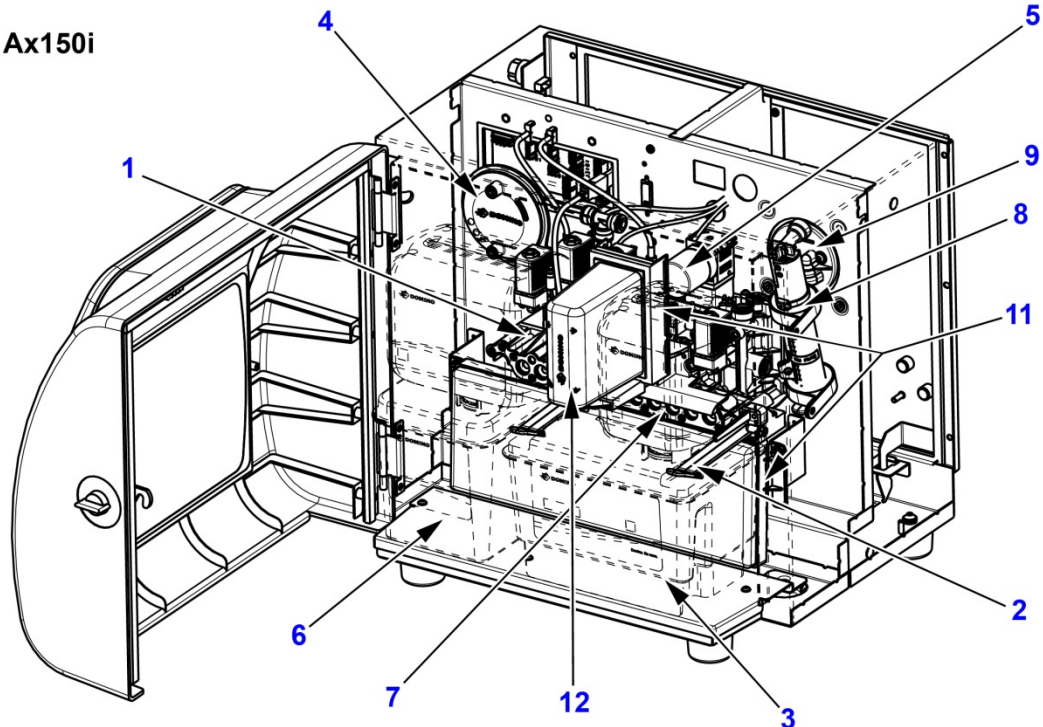
Image	Description	Quantity per kit
	<p>EPT040493SP Duo Flush Kit Adaptor Type 5 Spare</p>	<p>1</p>







Note: Item 10 Not Shown On Ax150i

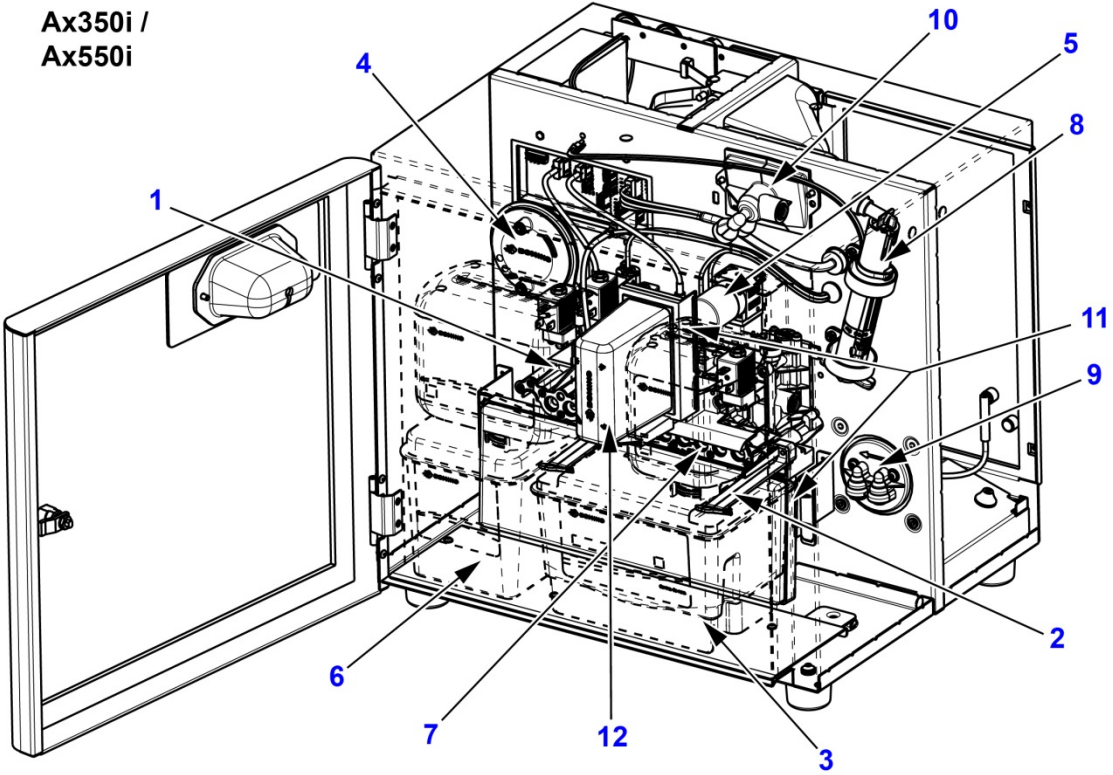
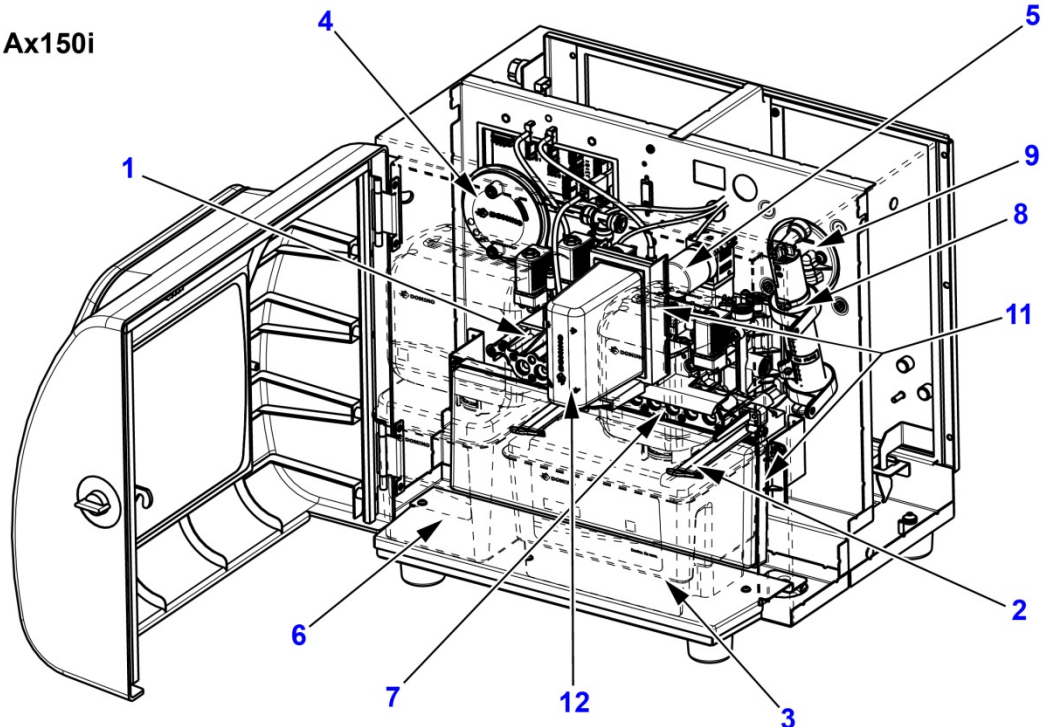
i-Techx System

Image	Description & Location	Quantity per kit
	<p>(1) EPT017902SP Distribution Block Assembly Type 5 Spare</p>	1
	<p>(2) EPT013403SP Module Latch (x2) Kit Type 5 Spare</p>	2
	<p>(3) ITM02 Ax-Series ITM Type 2 (Designed for Normal Ink System)</p> <p>ITM03 Ax-Series ITM Type 3 (Designed for Heavy Duty Ink System)</p> <p>ITM06 Ax-Series ITM Type 6 (Designed for Dye-Based Ink System)</p>	1 1 1
	<p>(4) EPT018872SP Damper Assembly Type 5 Spare</p>	1



Note: Item 10 Not Shown On Ax150i

Image	Description & Location	Quantity per kit
	<p>(5) EPT007517SP Gutter Pump Type 5 Spare</p>	<p>I</p>
	<p>(6) EPT009810SP Make-Up Module Type 5 Spare</p>	<p>I</p>
	<p>(7) EPT016786SP Make-Up Module Seal Plate Type 5 Spare</p>	<p>I</p>
	<p>(8) EPT013507SP Viscometer Assembly Kit Type 5 Spare</p> <p>Kit Components: Viscometer Assembly Basic General Build (Bayonet) LLDPE Tubing 6mm Natural</p> <p>Note: Tubing available separately.</p>	<p>I 0.4M</p>



Note: Item 10 Not Shown On Ax150i

Image	Description	Quantity per kit
	<p>(9) EPT023712SP Gear Pump Assembly Type 5 Spare</p> <p>Kit Components: Gear Pump LLDPE Tubing 6mm Natural LLDPE Tubing 8mm Natural</p> <p>Note: Tubing available separately.</p>	<p>I 0.435M 0.415M</p>
	<p>(10) EPT011411SP Peltier Assembly Type 5 Spare</p> <p>Ax350i & Ax550i Only</p> <p>Kit Components: Peltier Assembly LLDPE Tubing 6mm Natural</p> <p>Note: Tubing available separately.</p>	<p>I 0.91M</p>
	<p>(11) EPT013423SP LSM Assembly Type 5 Spare</p>	<p>I</p>
	<p>(12) EPT013186SP Quality Management Module Assembly Type 5</p>	<p>I</p>

Image	Description & Location	Quantity per kit
	<p>EPT012462SP Quality Management Module (QMM) (Made Up Of EPT013186 & EPT013423)</p>	<p>1</p>
	<p>EPT034279SP Tube Kit Type 5 Spare</p> <p>Kit Components: LLDPE Tubing 6mm Natural Tube 8mm x 415mm - LLDPE</p> <p>Note: Kit components not available separately.</p>	<p>2M 0.415M</p>
	<p>EPT016969SP Pressure Sensor Type 5 Spare</p>	<p>1</p>
	<p>EPT016967SP Vacuum Sensor Type 5 Spare</p>	<p>1</p>



Image	Description & Location	Quantity per kit
	<p>EPT018862SP Feed Filter Assembly Type 5 Spare</p>	<p>1</p>
	<p>EPT021504SP Low Drip Valve Type 5 Spare</p>	<p>1</p>
	<p>EPT023718SP Solenoid Assembly Ink Block Type 5 Spare</p>	<p>1</p>
	<p>EPT014014SP Temperature Sensor Type 5 Spare</p>	<p>1</p>





Image	Description & Location	Quantity per kit
	<p>EPT021516SP Jet Pump Kit Type 5 Spare</p> <p>Kit Components: Jet Pump Nozzle Vertical Shield O-Ring 12.45 x 1.78 EPDM O-Ring 6.5 x 1.5 EPDM</p> <p>Note: Kit components not available separately.</p>	<p>1</p>
	<p>EAS000789SP Make-Up Module Filter Ink System (i-Tech/Ax)</p>	<p>1</p>
	<p>EPT015798SP Heavy Duty Gear Pump Assembly Type 5 Spare</p> <p>Note: May vary depending on model and ink type, please contact Domino.</p>	<p>1</p>
	<p>Vanity Shield Spare</p> <p>EPT018246SP - Ax150i</p> <p>EPT011688SP - Ax350i & Ax550i</p>	<p>1</p> <p>1</p>

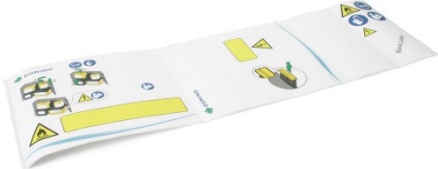



Image	Description & Location	Quantity per kit
	<p>EPT024197SP Print on Demand Label Ax-Series Spare</p> <p>Note: Please order this part via Oracle only - NOT BuyDomino. Information required below MUST BE ADDED as an attachment to the order line to produce the correct label -</p> <ul style="list-style-type: none"> - Machine type. - Machine serial number. - Ink type. - Language <p>Failure to provide this information will delay your order.</p>	<p>1</p>
	<p>EPT026037SP Filter For Flush Manifold Assembly Type 5 Spare</p>	<p>1</p>
	<p>EPT034806SP NK System NRV Assembly Type 5 Spare</p>	<p>1</p>
	<p>EPT039590SP Seal Kit Ax Sample Maker Spare</p> <p>Note: Used on Ax Sample Maker EPT032103</p>	<p>1</p>


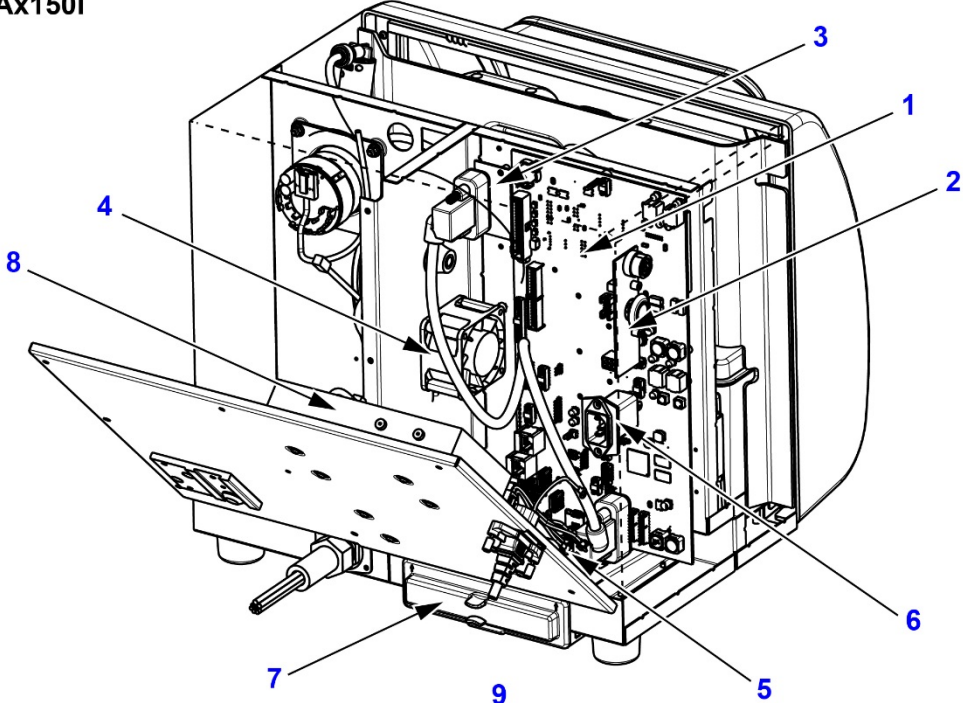
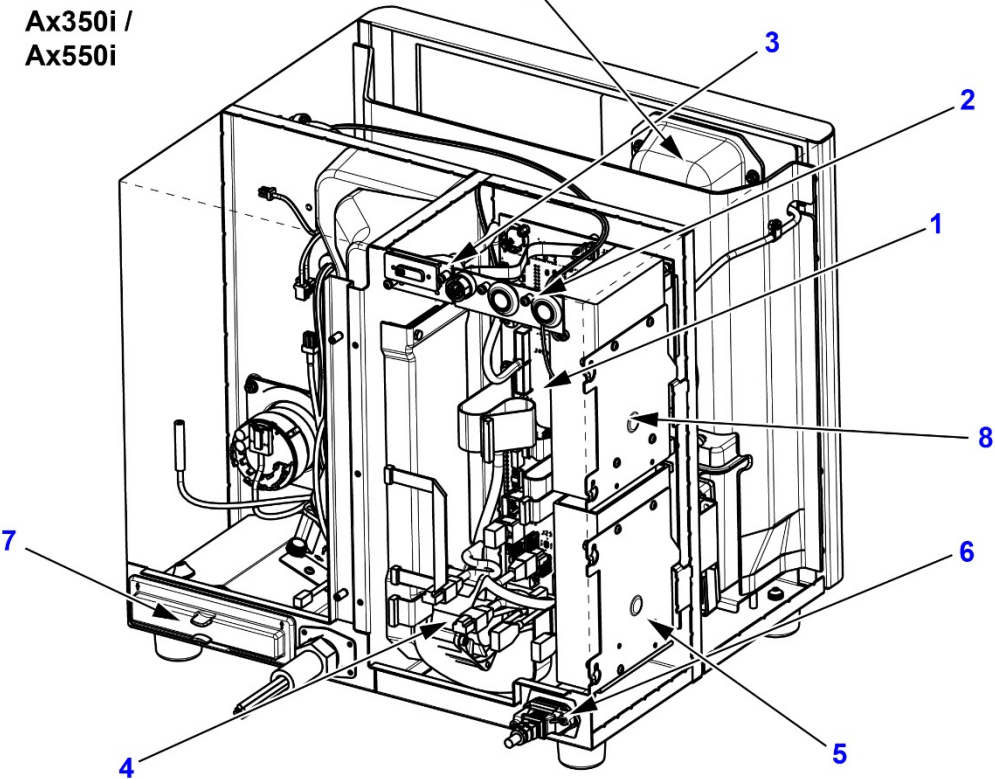
Image	Description & Location	Quantity per kit
	<p>EPT022060SP Cabinet Fasteners Kit Type 5 Spare</p> <p>Kit Components:</p> <p>Screw M3 x 10 BUT FLG Torx T10 SS K30 PLAS-TECH 60</p> <p>Screw M4 x 10 HEX HD SS Captive Washer 40</p> <p>Washer M4 Shake Proof St St 20</p> <p>Screw M5 x 8 CSK HD Torx T25 SS 30</p> <p>Screw M5 x 30 CAP HD Torx T25 SS 30</p> <p>Screw M4 x 20 HEX HD SS Captive Washer 40</p> <p>Screw M3 x 8 CSK HD Torx T10 SS 20</p> <p>Screw M3 x 8 BUT HD Torx T10 SS IP65 Nylon Washer 40</p> <p>Screw M3 x 8 BUT HD Torx T10 SS Captive Washer 100</p> <p>Screw M4 x 45 BUT HD Torx T20 SS Captive Washer 20</p> <p>Screw M3 x 5 BUT HD Torx T10 SS Captive Washer 40</p> <p>Note: Cabinet Fastener Kit components not available separately.</p>	

Image	Description & Location	Quantity per kit
	<p>EPT021551SP Ink System O-Ring Kit Type 5 Spare</p> <p>Kit Components: O-Ring 8.73 x 1.78 EPDM O-Ring 9.0 x 2.0 EPDM Reservoir O-Ring O-Ring 11.0 x 2.0 EPDM O-Ring 12.42 x 1.78 EPDM ORING 2.9X1.78 EPDM ORING 4_48X1_78 EPDM ORING 5.28X1.78 EPDM ORING 6.5X1.5 EPDM</p> <p>Note: Ink System O-Ring Kit components not available separately.</p>	<p>20 20 10 10 20 10 40 10 10</p>
	<p>EPT021552SP Ink System Fasteners Kit Type 5 Spare</p> <p>Kit Components: Screw 3 x 24.5 WNI56-2 T10 A2 Remform Screw K40 x 14 WNI45I Screw 3 x 10 WNI56-2 T10 A2 Remform Screw 3 x 8 WNI56-1 T10 A2 Remform Screw 3 x 18 WNI56-2 T10 A2 Remform</p> <p>Note: Ink System Fastener Kit components not available separately.</p>	<p>100 60 200 100 50</p>

Ax150i


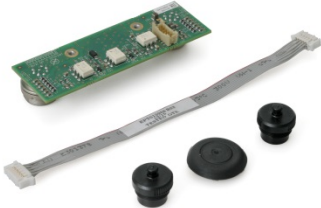




Ax350i /
Ax550i

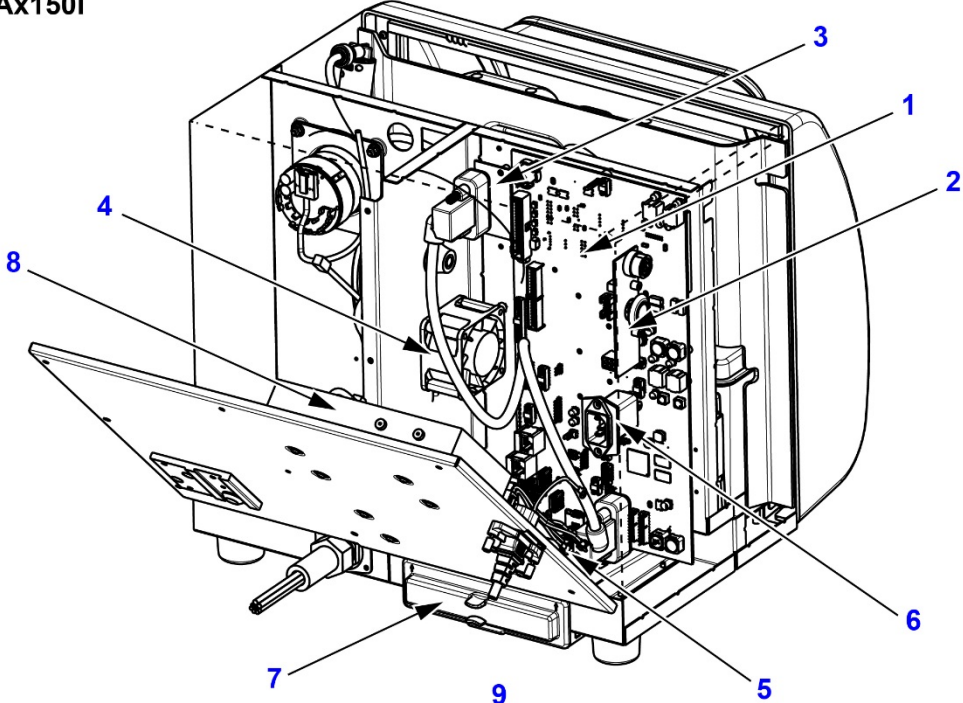


Note: Item 9 Not Shown On Ax150i

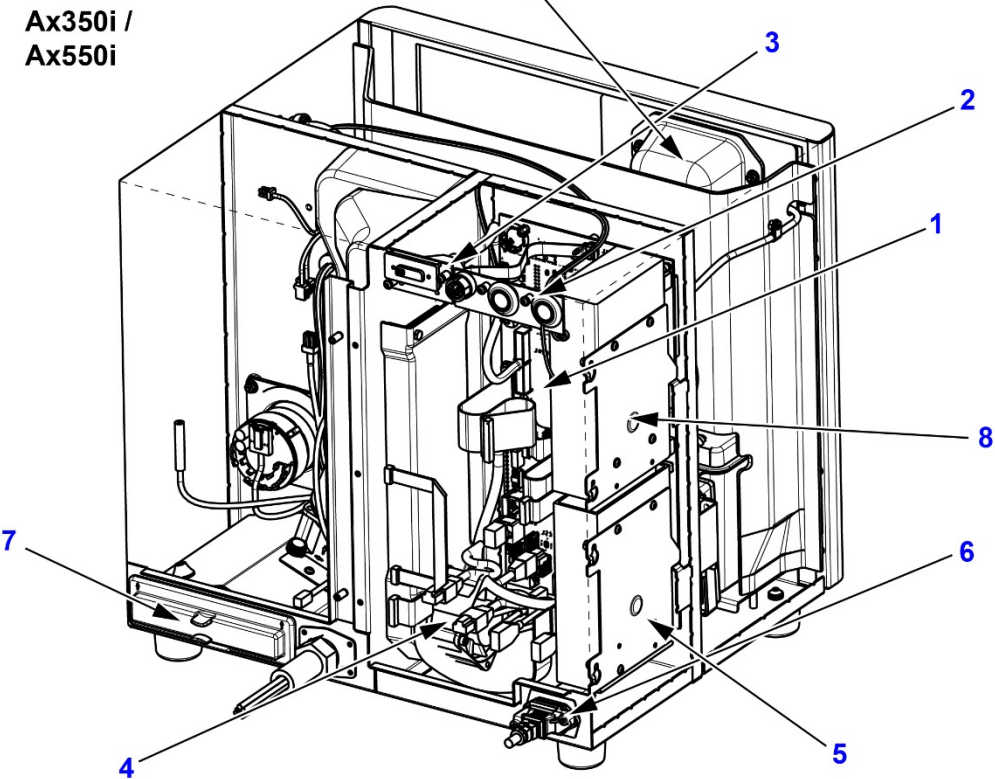
Electronics Cabinet

Image	Description & Location	Quantity per kit
	<p>(1) EPT017909SP Main Control PCB Type 5 Spare</p>	<p>1</p>
	<p>(2) EPT013308SP Product Detect / Shaft Encoder PCB Kit Type 5 Spare</p> <p>Kit Components: Product Detect / Shaft Encoder PCBA - Dual Cap, Protection, Female Socket Cable, Product Detect / Shaft Encoder</p> <p>Note: Kit components not available separately.</p>	<p>1 2 1</p>
	<p>(3) External User Interface PCB Kit Type 5 Spare</p> <p>EPT047162SP - Ax150i EPT012907SP - Ax350i/Ax550i</p> <p>Kit Components: User Interface PCBA Cable, UI</p> <p>Note: Kit components not available separately.</p>	<p>1 1</p>
	<p>(4) EPT017291SP Fan Type 5 Spare</p>	<p>1</p>

Ax150i



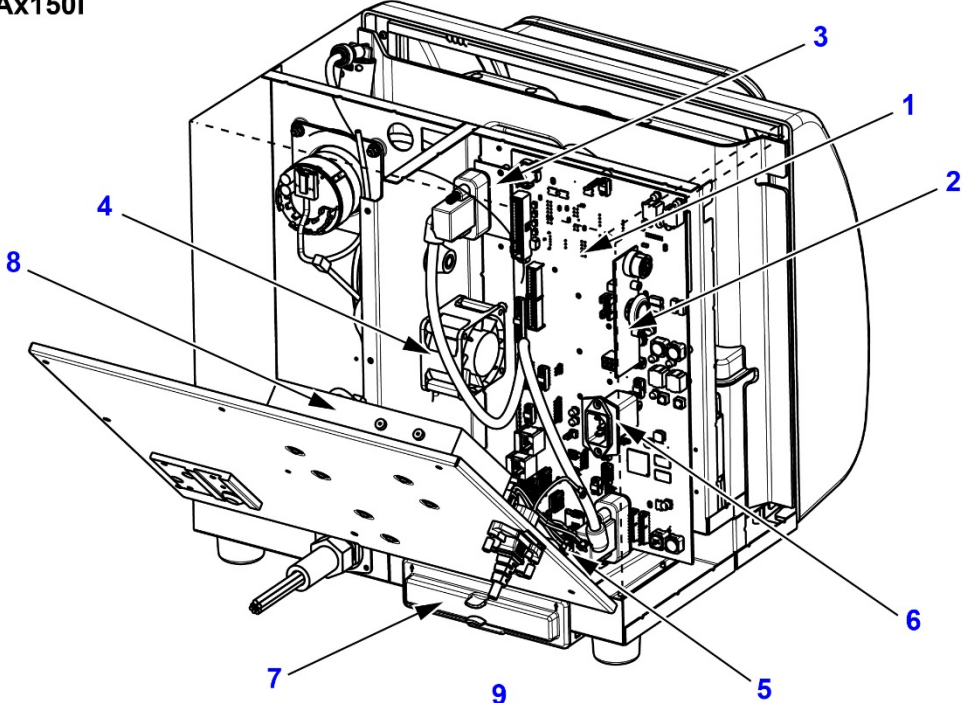
Ax350i / Ax550i



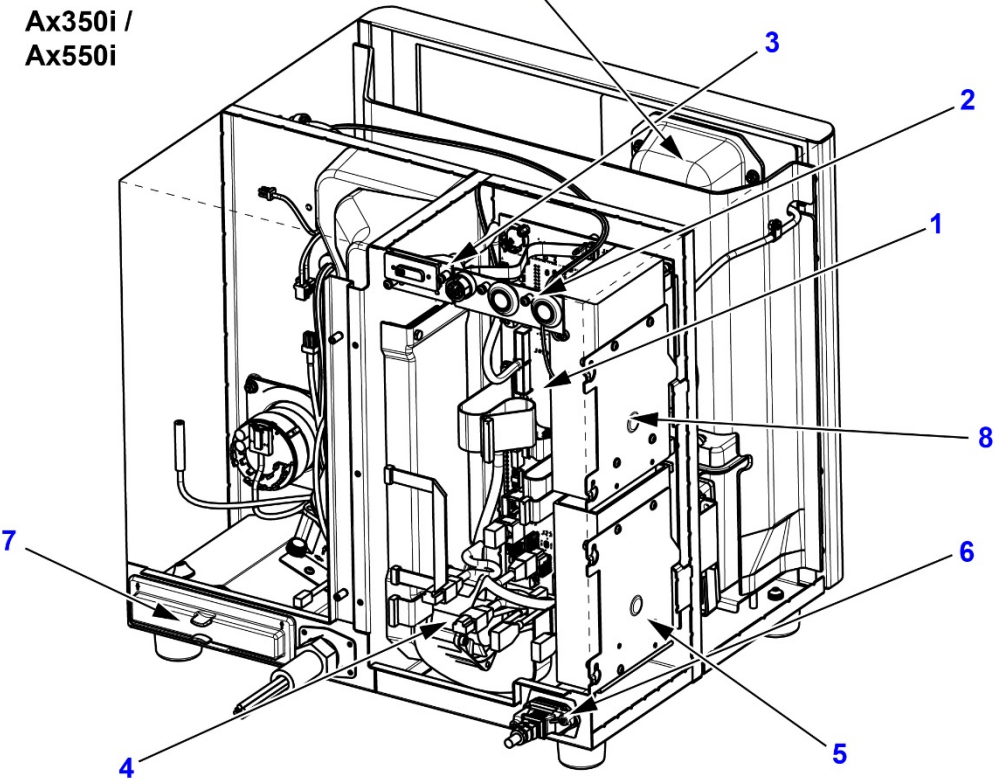
Note: Item 9 Not Shown On Ax150i

Image	Description & Location	Quantity per kit
	<p>(5) EPT033207SP LVPS 2 Ultrawide & 6A Power Connector Kit Spare</p>	<p>1</p>
	<p>(6) EPT026355SP Power Connector Type 6 Spare</p>	<p>1</p>
	<p>EPT015415SP Filter Assembly Type 5 Spare</p>	<p>1</p>
	<p>(7) EPT016386SP Filter Handle Type 5 Spare</p>	<p>1</p>
	<p>(8) EPT006886SP High Voltage PSU Type 5 Spare</p>	<p>1</p>

Ax150i



Ax350i / Ax550i



Note: Item 9 Not Shown On Ax150i

Image	Description	Quantity per kit
	<p>(9) EPT014385SP Keypad Membrane, 4 Button (Ax350i/550i) Spare</p> <p>Ax350i & Ax550i Only</p> <p>Kit Components: Keypad Membrane, 4 Button Cable, Keypad Cover, Keypad</p> <p>Note: Kit components not available separately.</p>	<p style="text-align: center;"> </p>
	<p>EPT028743SP Front Door UI Parts Kit (Ax150i) Spare</p> <p>Kit Components: Screw M3 x 10 BUT FLG Torx T10 SS K30 PLAS-TECH PCBA 7" UI HEX Stand Off Cable, UI Cable, Keypad 7" UI Front Assembly</p> <p>Note: Kit components not available separately.</p>	<p style="text-align: center;">12 2 </p>
	<p>EPT013856SP Cable, UI Spare</p>	<p style="text-align: center;"> </p>
	<p>EPT013987SP Cable, Keypad Spare</p>	<p style="text-align: center;"> </p>

Image	Description	Quantity per kit
	<p>EPT019062SP 7" UI Front Assembly Spare</p>	<p>1</p>
	<p>EPT019071SP PCBA 7" UI Spare</p>	<p>1</p>
	<p>EPT029088SP Front Door Assembly (No UI) Parts Kit (AxI 50i) Spare</p>	<p>1</p>
	<p>EPT019979SP 32KB Smart Card Type 5 Spare</p>	<p>1</p>



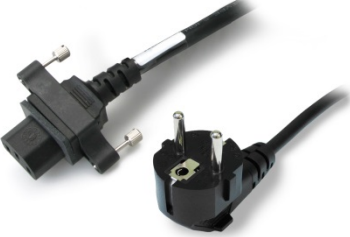




Image	Description	Quantity per kit
	<p>EPT015153SP Solenoid Valve Harness, Type 5 Spare</p>	<p>1</p>
	<p>EPT014018SP Mains Lead (UK) Type 5 Spare</p>	<p>1</p>
	<p>EPT020200SP Mains Lead (Europe) Type 5 Spare</p>	<p>1</p>
	<p>EPT020198SP Mains Lead (USA) Type 5 Spare</p>	<p>1</p>

Image	Description	Quantity per kit
	<p>EPT020197SP Mains Lead (China) Type 5 Spare</p>	<p>1</p>
	<p>EPT020202SP Mains Lead (India) Type 5 Spare</p>	<p>1</p>
	<p>EPT029254SP Mains Lead (Taiwan) Type 5 Spare</p>	<p>1</p>
	<p>EPT032070SP Mains Lead (Argentina) Type 5 Spare</p>	<p>1</p>

Image	Description	Quantity per kit
	<p>EPT020193SP Mains Lead (No Plug) Type 5 Spare</p>	<p>1</p>
	<p>EPT022059SP Blanking Plugs & Caps Kit Type Spare</p> <p>Kit Components: Blanking Plug, Large Blanking Plug, Medium Blanking Plug, Small Cap, Protection, Male Socket Cap, Protection, Female Socket Grommet 17mm Blind</p> <p>Note: Kit components not available separately.</p>	<p>1 1 1 1 1 1</p>
	<p>EPT019977SP Programmed 8GB Flash Card Type 5 Spare</p>	<p>1</p>
	<p>EPT032093SP Encoder Cable, Inline Signal Conditioner Spare</p>	<p>1</p>

Image	Description	Quantity per kit
	<p>EPT035140SP Extended Print Head Bracket and Holster Kit For Moba Egg Graders (Ax-Series) Spare</p> <p>Kit Components: Print Head Mounting Plate (Long) Kit A-Series Holster, Standard - No Slots</p> <p>Note: Kit components not available separately.</p>	<p>1</p> <p>1</p>
	<p>EPT041081SP DCI Port Kit</p>	<p>1</p>
	<p>01210 Fuse 20x5 (T) 1A (240V)</p>	<p>1</p>

AirDryer Spares



Image	Description	Quantity per kit
	EPP004073SP Air Shut Off Solenoid Valve MK3	1
	EPP004074SP Flow Control Valve MK3	1
	EPP004075SP Pressure Switch MK3	1
	EPP004076SP Filter Regulator with Constant Bleed Drain MK3	1

Image	Description	Quantity per kit
	<p>EPP004077SP Filter Media MK3</p>	<p>1</p>
	<p>EPP004162SP 6mm Bulkhead Connector & 6mm - 4mm Reducer Kit Spare</p>	<p>1</p>